



GAS POWERED AIRSOFT GUN

1/1 SCALE HIGH PERFORMANCE ASSEMBLED



M-92(L)



AUTO

M-92

INSTRUCTION MANUAL

LENGTH:225mm WIDTH:39mm HEIGHT:139mm WEIGHT:1100g

GAS POWERED AIRSOFT GUN

GAS FULL PRESSURE AUTO BLOWBACK GUN

FOR AGE 18 YEARS OR OLDER

MADE IN TAIWAN



GAS POWERED AIRSOFT GUN

1/1 SCALE HIGH PERFORMANCE ASSEMBLED



AUTO

M-92

INSTRUCTION MANUAL

LENGTH:216mm WIDTH:39mm HEIGHT:139mm WEIGHT:1050g

GAS POWERED AIRSOFT GUN

GAS FULL PRESSURE AUTO BLOWBACK GUN

FOR AGE 18 YEARS OR OLDER

MADE IN TAIWAN

1 各部名稱 NAME OF PARTS



2 瓦斯注入方式 GAS INJECTION

■ 瓦斯注入
填充氣體務必垂直

□ Gas injection
To refill the gas with the gas container in vertical position.

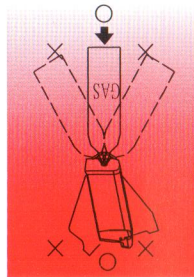

3 裝填BB彈 LOADING BB BULLET

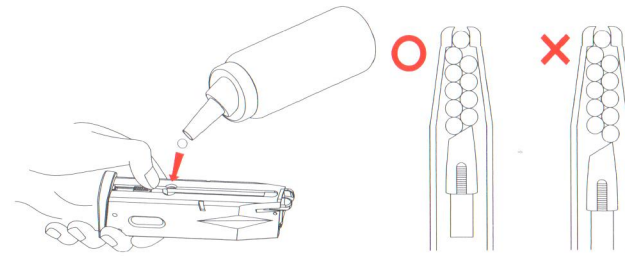

■ BB彈裝填
裝填BB彈6mm(25發入)

□ Loading BB bullet
Load BB bullet in the magazine, 6 mm (25 rounds only)

請勿使用超過6mm、表面不平整、或使用過之BB彈

Please do not use the BB bullets that are over 6mm, rough on surface or have been used.



! CAUTION !

■ 請依照圖示之排列方式裝填BB彈

□ Please follow the illustrative sequences to load the BB bullets.

4 上彈匣 LOADING & RELEASING THE MAGAZINE

■ 彈匣入退要點

入彈匣時推到底如聽“答”一聲即到定位，押下彈匣卡筴，彈匣即會脫離 **注意：務必用手托住彈匣，以免造成掉落破損**

□ Load and release the magazine
While loading the magazine, push it inward to the bottom till a "tick" sound is heard. Press the magazine release catch, the magazine will fall off from the stock. **Attention: use hand to receive the magazine to prevent it from falling down to the ground.**

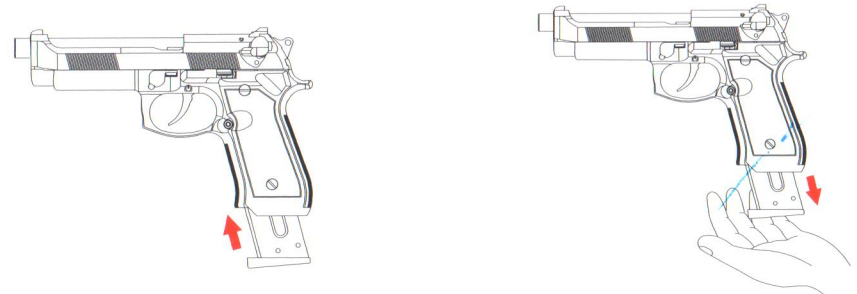

5 上膛-第一次射擊上彈 FIRST LOAD FOR FIRING

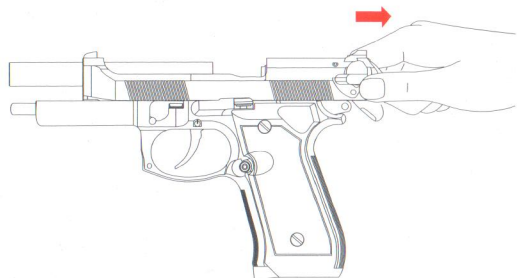

■ 第一次射擊之送彈

初次擊發時需將滑套往後退至定點放開後滑套向前上膛擊鎚卡於後方即可發射

□ First load of bullet for firing

Pull the slide backward to a specific position, then release and let the slide moving forward to load the bullet in the firing chamber, and retain the hammer at the rear position, ready for firing.

6 開關保險 SAFETY OPERATION

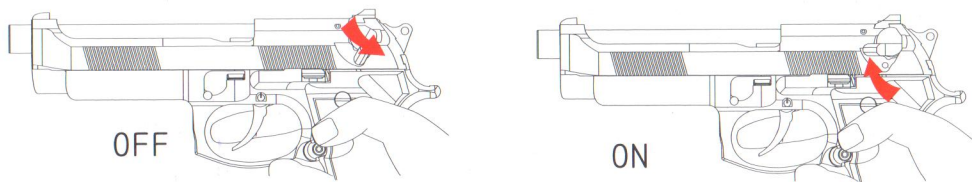

■ 保險 (安全裝置)

□ Safety (protection device)

7 第一次射擊 FIRST SHOOTING

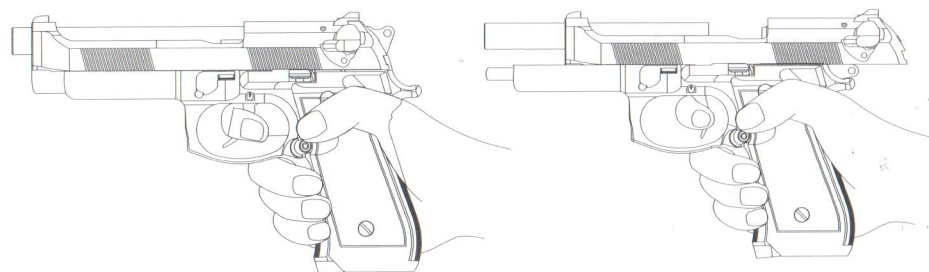

■ 初次裝填彈擊發時需先將滑套後拉使其BB彈上膛，擊扣扳機即可發射 注意：填充子彈以25發為限

BB彈發射完畢，滑套定位於後方此為無子彈之狀態，如欲繼續射擊填充子彈後下按滑套保險後上膛

□ When the slide is pulled back and released forward, the bullet is load-ed in the firing chamber, press the trigger to fire the loaded bullet.

Attention: The maximum containment for a magazine is 25 rounds. After the last BB bullet is fired, the slide will be retained in the back position, it means an empty magazine condition. If you want to resume the firing, insert a new fully loaded magazine, press the slide stop to release the slide and to reload the bullet.

8 射擊過程 SHOOTING PROCESS



■長時間連續發射容易使彈匣過於低溫，影響氣體壓力及子彈初速，此為正常現象非故障所致擊發時請勿倒轉擊發此動作無法使氣體揮發產生霧氣噴出容易導致零件耗損

- After a long and continued firing practice, the low temperature of the magazine will cause a reduced gas pressure as well as the low velocity of bullet. It is a normal condition, not a trouble. Never practice the reverse firing for this action renders the gas hardness to volatilize and to produce the atomized gas of ejection which leads the damaged to the parts.

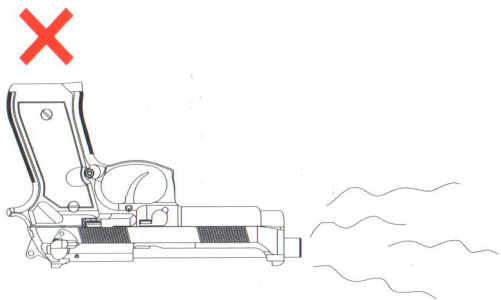

9 射擊完畢 AFTER SHOOTING

■ 發射完畢

發射完畢欲收藏時，請將彈匣取出後按下滑套保險，使滑套就定位，擊扣扳機讓擊鎚回復定位

注意：如有子彈請取出

- AFTER THE FIRING PRACTICE
After the firing practice, take off the magazine from the stock, push down the slide stop to hold the slide in place and press the trigger to release the hammer.

Attention: Take out any bullet that is inside.

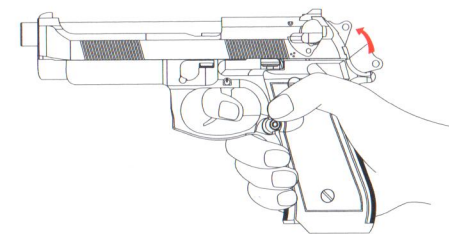
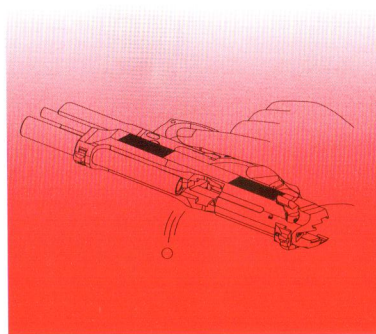
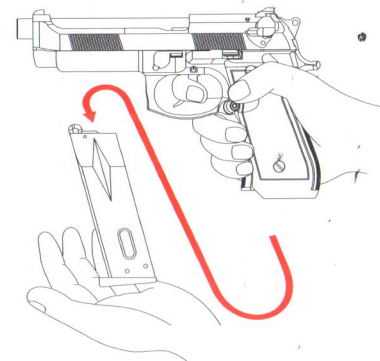

10 大部分分解 MAJOR DISASSEMBLY

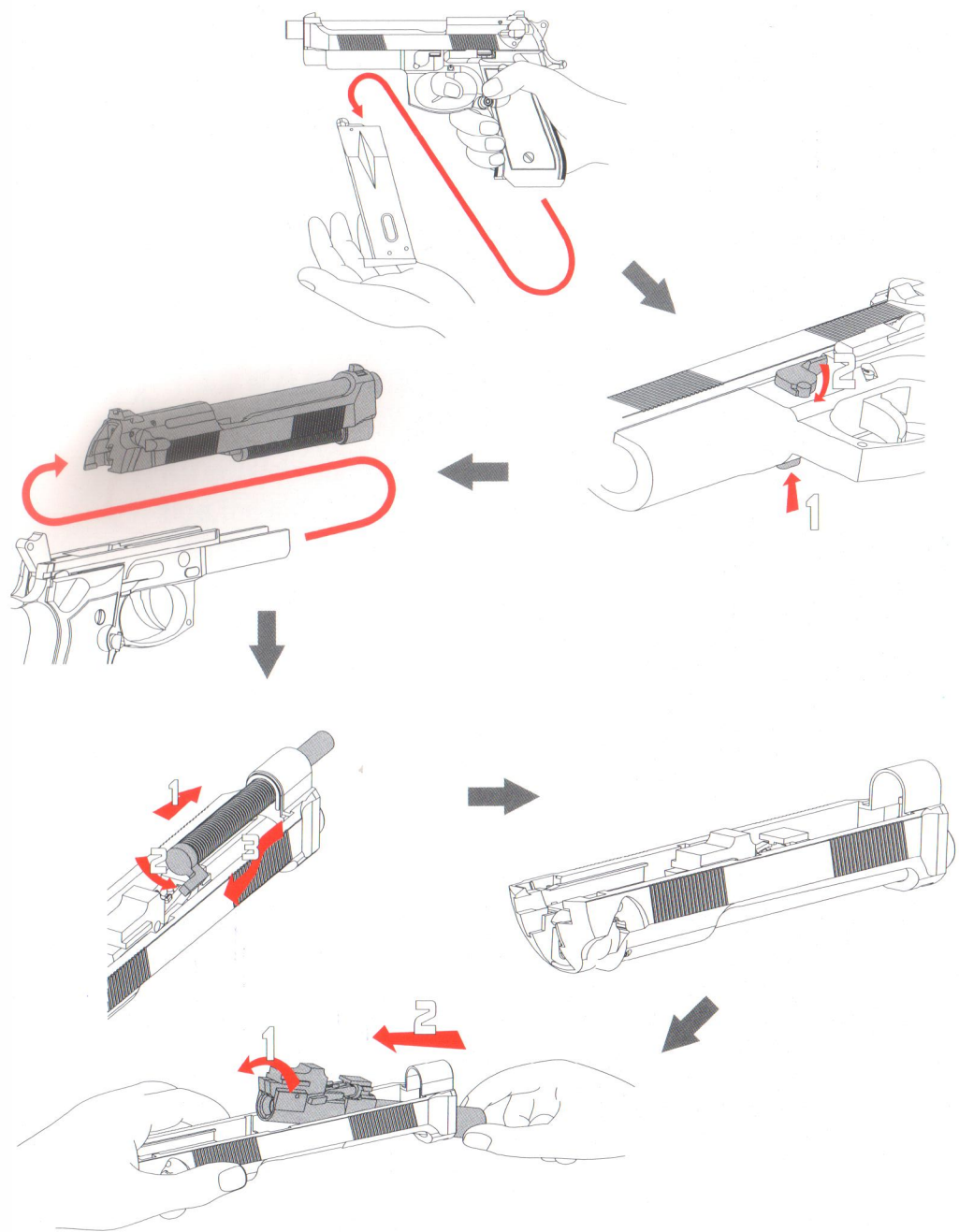

11 組合 ASSEMBLY

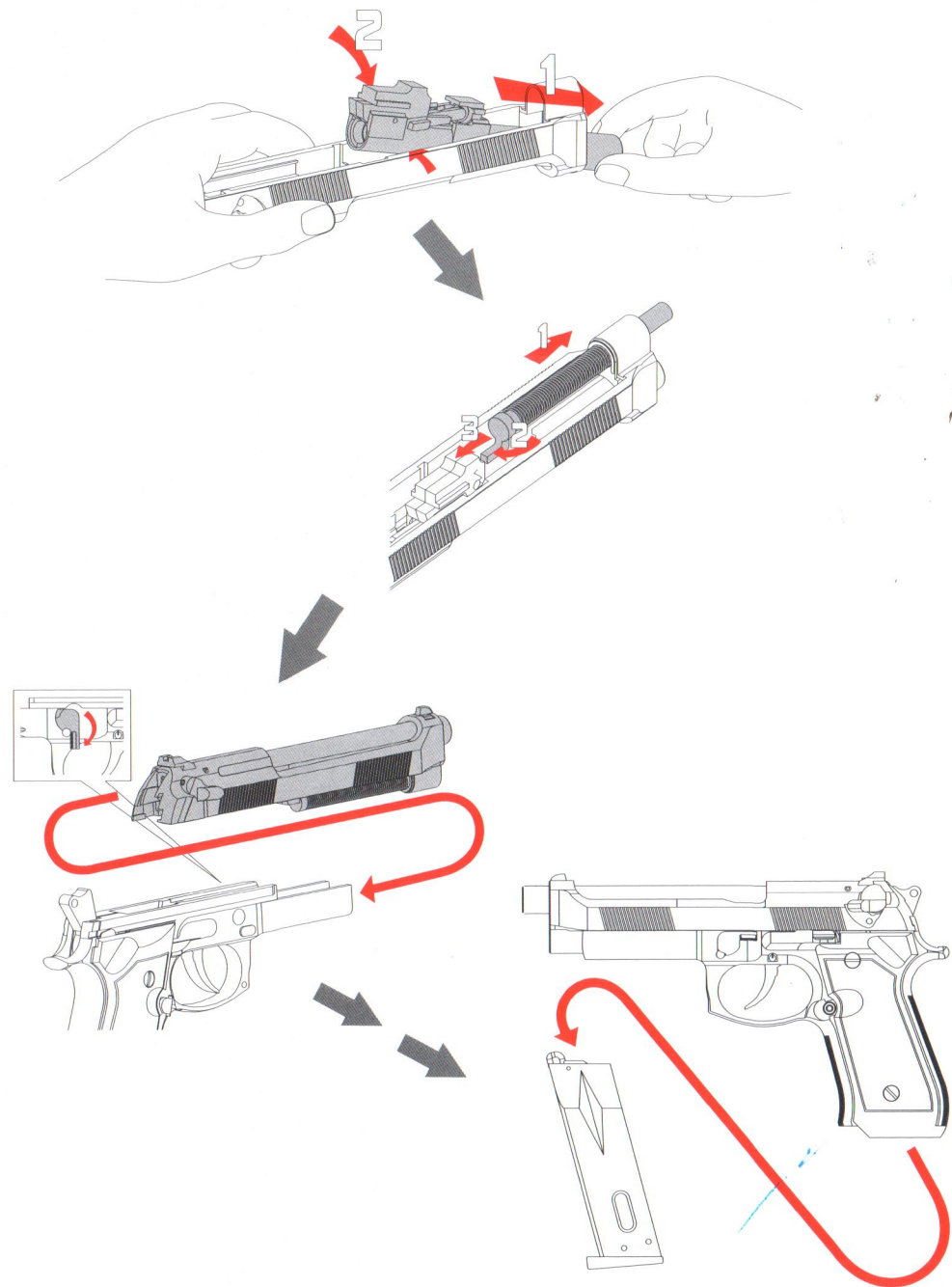

12 維修保養 BASIC MAINTENANCE

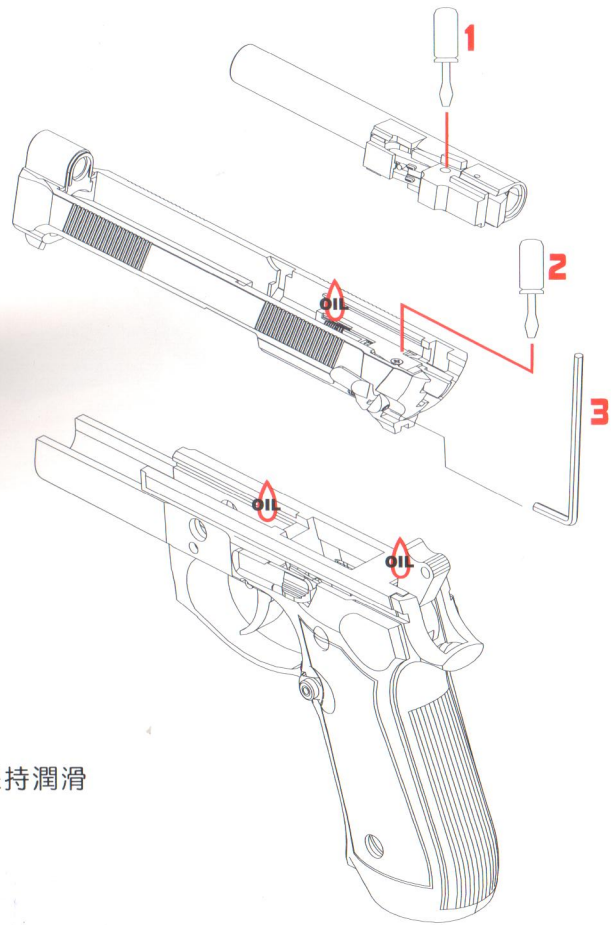

請上油保持潤滑

1 2 3 檢查是否鬆動，若有鬆動請鎖緊以確保使用安全

爆炸圖 EXPLOSION

AUTO MODE

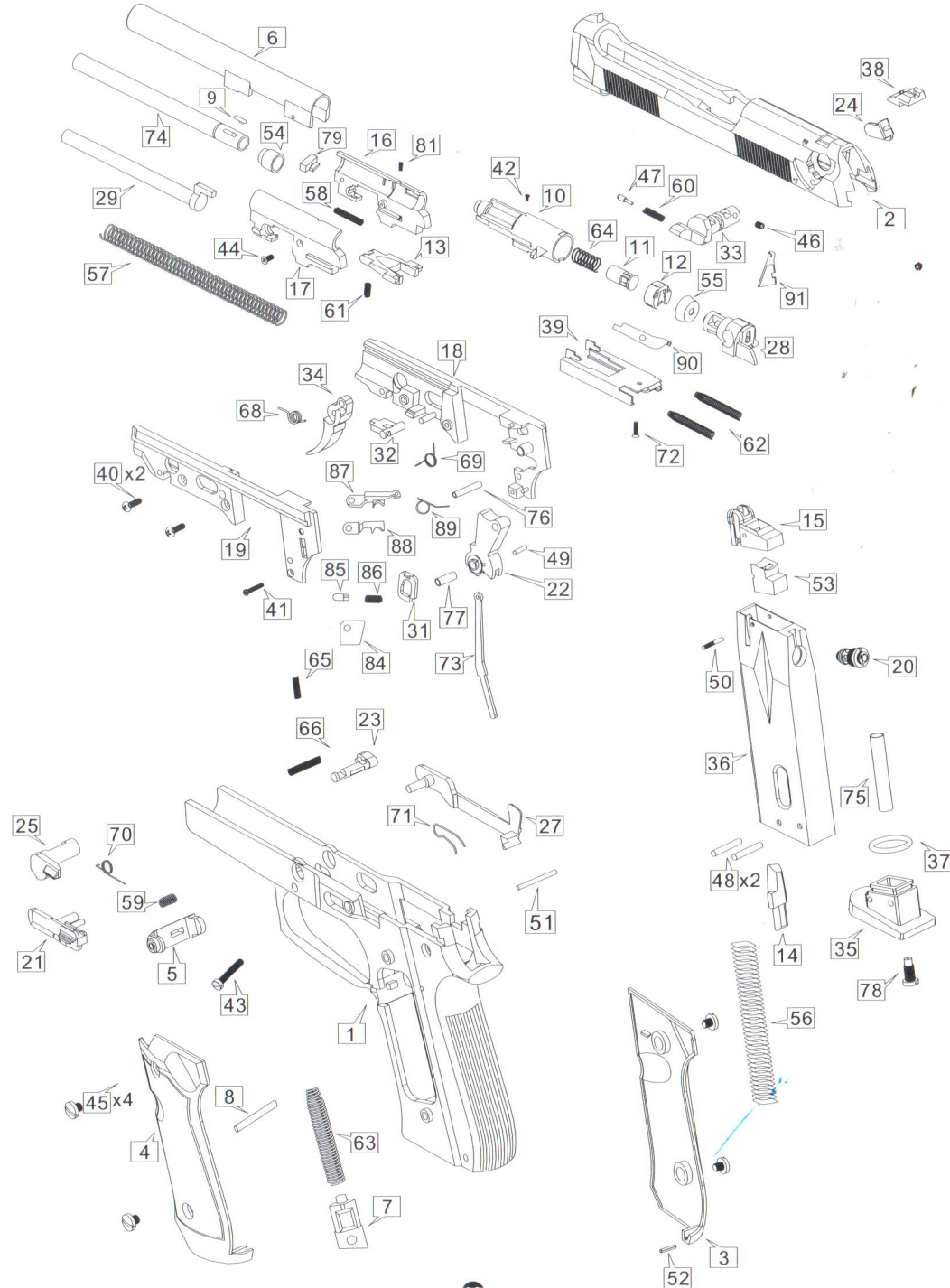

14 故障排除 TROUBLE RESOLUTION

槍枝狀況	原因	處理方法
無法動作	關閉保險	將保險解除即可
	彈匣瓦斯過多	由充氣口或出氣閥向下按壓釋放少量氣體即可 注意:釋放氣體時不可對準火源以及人畜
	彈匣瓦斯不足	填充瓦斯氣體容量不足或特別低溫之情況 解決方法:填充適量瓦斯氣體即可
	不明原因	請至購買之經銷店維修
無法出彈	BB 彈變形	請勿選用使用過和選用劣質 BB 彈
	彈道孔內有異物	彈匣上彈道內 BB 彈擠壓卡住或有異物阻塞將雜物清除即可
	給彈結構部份損傷	請至購買之經銷店維修
滑套無法回復定位	給彈口附近有異物阻塞	將異物清除即可
BB 彈發射滑套動作不順	氣溫過低(冬季時)	將彈匣放置室內待溫度回復方可使用
	彈匣瓦斯不足(1 個彈匣長時間使用或連續快速連發射,造成快速冷結冰)	建議使用兩個彈匣交替使用
	彈匣氣壓不足	填充瓦斯即可
	擊發結構損壞	請至購買之經銷店維修
	氣密橡膠摩擦破損	請至購買之經銷店維修
BB 彈射程不夠	運動之潤滑不夠	參考潤滑作業程序
	入彈橡膠破損	
	彈簧彈性疲乏	請至購買之經銷店維修
	出氣口結構損壞	

14 故障排除 TROUBLE RESOLUTION

Condition	Causes	Correction
No action	Safety is locked	Release the safety
	Too much gas	Press the refill inlet or the drain valve to breed an adequate amount of gas. Caution: Never aim the discharged gas to a fire, animal or person.
	Insufficient gas	Insufficient gas filled or at a very low temperature. Solution: Inject an adequate amount of gas into the gun.
	Unknown reason	Please contact our distributor.
No load of bullet	Deformed BB bullet	Use the standard BB bullet only.
	The bore is clogged with extraneous material	Remove the extraneous material from the bore.
The slide fails to return to the position	An extraneous material jams at the front end of the barrel	Remove the extraneous material
The motion of the slide is not smooth while firing BB bullet	The ambient temperature is too low (in winter)	Place the magazine indoor to recover the temperature. It is recommended to prepare two magazines.
	Insufficient gas in the magazine (a long and continued firing causes quick cooling and frozen)	Refill the gas
	Low gas pressure in the magazine	
	The trigger mechanism is out of work	Please contact our distributor.
Short projectile	The air-tight rubber seal is worn out or damaged	
	Poor lubrication	Please carry out the periodic lubrication accordingly
	The gas discharging mechanism is broken	Please contact our distributor

Condición Irregular	Causa	Solución
No puede usar	Seguro Cerrado	Librar el seguro
	Demasiado gas	Pulsar la salida de aire hacia abajo. Advertencia: Al desechar el aire, no la ponga contra el fuego o animal.
	Gas del cartuche insuficiente	La condición del contendio del gas insuficiente o temperatura baja. Solución: Rellenar el gas
La bala no sale	Causa no conocida	Lleve la pistola al distribuidor
	Desformación de la bala	No use las balas usadas o de mala calidad.
	Cosa desconocida en la trayectoria	Las balas torsidas o algo desconocido queda en la trayectoria. Solución: Qútelos.
El deslizador no vuelve a su posición	Daños en las partes de suministrar las balas	Lleve la pistola al distribuidor
	Algo congestiona en la parte de suministrar las balas	Quite las cosas.
El movimiento del deslizador extraño cuando dispara.	Temperatura demasiada baja (en invierno)	Ponga el cartuche de bala en temperatura ambiental.
	Gas del cartuche insuficiente (Se usa el cartuche por mucho tiempo o dispara rápida y continúa, y causa la congelación.	Recomendación: Use dos cartuches en turno.
El movimiento del deslizador extraño cuando dispara.	Presión de cartuche insuficiente	Rellenar el gas
	Daño en la composición de disparo	Lleve la pistola al distribuidor
	Rotura o desgaste del hule	
	Lubricante insuficiente	Consulte el procedimiento del lubricación
Alcance de fuego insuficiente	Rotura del hule	Lleve la pistola al distribuidor
	Fatiga del elevador	
	Daño en la composición de la salida de aire	

14 故障排除 TROUBLE RESOLUTION

Problem	Ursache	Lösung
Schießt nicht.	Gerät ist gesichert	Entsichern Sie.
	Zu viel Gas	Drücken Sie auf die Wiederfülleinlage oder das Ablassventil, um die Gasmenge zu beeinflussen. Vorsicht: Während Sie Gas ablassen, zielen Sie mit dem Gerät nicht auf Feuer, Tiere oder Personen.
	Zu wenig Gas	Zu wenig Gas aufgefüllt oder zu geringe Temperatur. Lösung: Füllen Sie das Gewehr mit der entsprechenden Gasmenge auf.
	Unbekanntes Problem	Wenden Sie sich an den Fachhandel.
Geschosse lassen sich nicht laden.	Deformierte BB-Geschosse	Benutzen Sie nur Standard BB-Geschosse.
	Der Lauf ist verstopft.	Entfernen Sie Verstopfungen aus dem Lauf.
Der Gleitzug geht nicht auf seine Position zurück	Verunreinigungen blockieren das vordere Ende des Gewehrschafts.	Entfernen Sie Verunreinigungen
Während der Benutzung von BB-Geschossen bewegt sich der Gleitzug unregelmäßig.	Die Umgebungstemperatur ist zu niedrig (Winter)	Legen Sie das Magazin an einen Ort mit Normaltemperatur. Es wird nicht empfohlen, zwei Magazine bereit zu halten.
	Nicht ausreichend Gas im Magazin (langes ununterbrochenes Schießen verursacht schnelle Abkühlung)	Füllen Sie das Gas auf.
	Niedriger Gasdruck im Magazin	
	Der Abzugsmechanismus ist gestört.	Bitte kontaktieren Sie den Fachhändler.
	Der luftdichte Gummiverschluss ist verschlissen oder beschädigt.	
	Schlechte Schmierung	Bitte schmieren Sie das Gerät in periodischen Abständen.
Kurze Schussweite	Der Gummiverschluss ist beschädigt.	Bitte kontaktieren Sie den Fachhandel.
	Die Feder ist verschlissen.	
	Der Gasablass-Mechanismus ist gestört.	

Condition	Causes	Correction
Non succede nulla	La sicura è bloccata	Togliete la sicura
	Troppo gas	Premete la presa di riempimento o la valvola di drenaggio per fornire una quantità adeguata di gas. Nota bene: non sparate mai il gas contro fuoco, animali o persone.
	Gas insufficiente	Gas insufficiente o a temperatura molto bassa. Soluzione: caricate una quantità sufficiente di gas nel fucile.
	Ragione sconosciuta	Contattate il distributore.
I proiettili non si caricano	Proiettile BB deformato	Usate solo i proiettili BB standard
	L'anima è inceppata per via di oggetti estranei	Togliete gli oggetti estranei dall'anima
Il carrello non ritorna in posizione	Un oggetto estraneo lo blocca nella parte anteriore della canna	Togliete l'oggetto estraneo
Il movimento del carrello non è scorrevole durante lo sparo dei proiettili BB	La temperatura è troppo bassa (in inverno)	Mettete il caricatore al riparo per tornare alla temperatura normale. Si raccomanda di preparare due caricatori.
	Gas insufficiente nel caricatore (una lunga sessione di sparo causa raffreddamento veloce e congelamento)	Riempite con altro gas
	Pressione bassa del gas nel caricatore	
	Il meccanismo del grilletto non funziona	Contattate il distributore
	Il sigillo di gomma a tenuta d'aria è consumato o danneggiato	
	Poca lubrificazione	Svolgete regolarmente le operazioni di lubrificazione
Proiettili sparati a poca distanza	Il sigillo di gomma è danneggiato	Contattate il distributore
	La molla non funziona bene	
	Il meccanismo di sparo del gas è rotto	

警告 ★ 正確使用空氣軟槍，可享受愉快的射擊，但是錯誤的使用方法非常危險，務必遵守下列注意事項

□ Caution!

▲ PRECAUTION

NE PAS UTILISER D'AUTRES





PROJECTILEE QUE CEUX FOURNIS.

△ VORSICHT

Ausschliesslich für diese Pistole bestimmte

Munition verwenden. (5.5mm Kunststoffkugeln)

○ Fare attenzione

<p>○ ★ 射擊時最好戴護目鏡</p> <p>□ Be sure to wear shooting glasses or Goggle when shooting.</p> <p>▲ Toujours porter des lunettes de tir ou de protection quand vous tirez.</p> <p>△ Zum Schiessen stets eine Schutzbrille tragen.</p> <p>■ Aseguresse de llevar puestas las gafas de proteccion cuando dispares.</p> <p>○ Assicurarsi di indossare lenti di Protezione quando si spara</p> 	<p>★ 不用時要把槍置於高處 (小孩拿不到的高處)</p> <p>□ Put the gun beyond the reach of kids.</p> <p>▲ Tenir hors de portee des enfants.</p> <p>△ Pistole immer kindersicher aufbewahren.</p> <p>■ Ponga la pistola fuera del alcance de los niños.</p> <p>○ Tenere fuori Dalla portata dei bambini.</p> 
<p>★ 不可用眼睛探視槍</p> <p>□ Don't peep at the muzzle.</p> <p>▲ Ne jamais regarder dans le canon.</p> <p>△ Nie in den lauf schauen.</p> <p>■ Jamas mire por el canon</p> <p>○ Non guardare mai dentro la canna.</p> 	<p>★ 不可朝人射擊</p> <p>□ Don't aim at people even if it is unloaded.</p> <p>▲ Ne jamais viser quelqu'un meme si votre pistolet est vide.</p> <p>△ Auch bei spiel-und Sportwaffen besteht Verletzungsgefahr. Auch ungeladen nie auf einen Menschen oder ein Tier richten!</p> <p>■ No apunte a personas, incluso descargado.</p> <p>○ Non puntare mai verso le persone anche se la pistola scarica.</p> 
<p>★ 射擊的瞬間，才可以把手指接近扳機擊扣</p> <p>□ Don't touch the trigger until the moment of shooting.</p> <p>▲ Ne jamais appuyer sur la gachette le rearmement.</p> <p>△ Abzug erst dann berühren, wenn Sie zum Schiessen bereit sind.</p> <p>■ No toque el gatillo hasta el momento del disparo.</p> <p>○ Non toccare il grilletto fino al momento di sparare.</p> 	<p>★ 確定射擊的方向均安全後才可以射擊</p> <p>□ After making sure that there is nobody nearby.</p> <p>▲ Toujours etre sur qu'il n'y a personne dans la trajectoire de votre tir.</p> <p>△ Vergewissern Sie sich vor dem Schiessen stets, dass niemand getroffen werden kann.</p> <p>■ Antes de apuntar aseguese que no hay nadie cerca.</p> <p>○ Assicurarsi sempre che non ci sia nessuno sulla traiettoria di tiro.</p> 
<p>★ 避免粗魯的動作，發生危險</p> <p>□ Avoid a rough operation.</p> <p>▲ Ne jamais jeter le pistolet quand il est arme.</p> <p>△ Geladene Waffe stets mit Respekt Behandln. Nicht werfen oder unsanft Jandhaben.</p> <p>■ No tire ni lance la pistola, se puede disparar.</p> <p>○ Evitare azioni brusche.</p> 	<p>★ 不使用時，應將彈匣取出，並取下子彈</p> <p>□ When the gun is not in use, remove the magazine and unload BB pellets.</p> <p>▲ Quand vous ne l'utilisez plus, bien Faire attention de retirer le chargeur et de le desarmer.</p> <p>△ Zum Aufbewahren Magazin entfernen und Kugeln herausnehmen.</p> <p>■ Cuando no se este utilizando la pistola, saque todas las bolas.</p> <p>○ Quando l'arma non e in uso, estrarre il caricatore e scaricare i pallini.</p> 